

YOUR NEW IKEA KITCHEN



from start



to finish

This guide will help you through all the steps you need to take along the way, including everything from finding your style and measuring your IKEA kitchen to plan, order and install it.

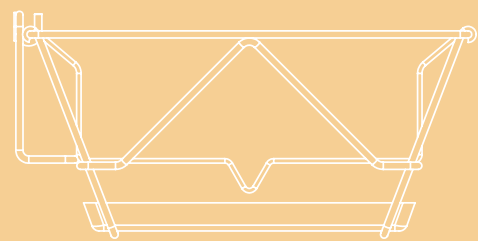
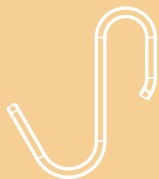
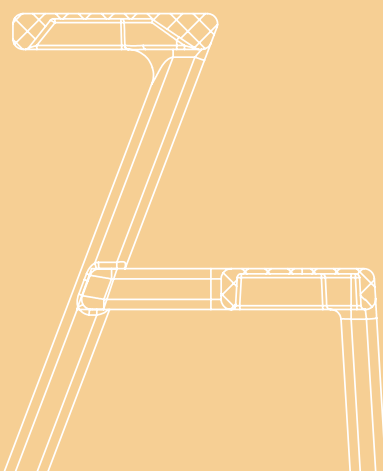
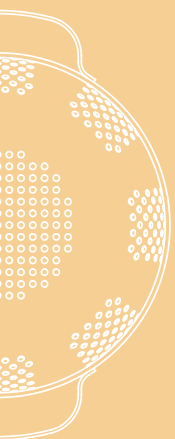

LET'S GET STARTED



WITH YOUR NEW IKEA KITCHEN

At IKEA, you'll find all the products you need to realise a complete dream kitchen. Whether your kitchen is large or small, we can offer you a wide range of well-designed and coordinated kitchen products that'll support your every need, style and personality. Plus, we've designed our kitchens to be simple enough for you to put together by yourself.

p.6

Find your style

Take some time to dream a little. What does an ideal kitchen look like to you, and what should it include? We show you where to search for inspiration and ideas.

p.10

Plan

Outline your kitchen and see what it will look like. We provide you with recommendations and tips.

p.7

Measure

The measurements are important as they will be the base for your new kitchen. We show you how to do it.

Table of contents

Find your style

Take some time to dream a little

This is when your dreams and ideas will start to take shape. Add your needs and what your ideal kitchen looks like and you'll for sure find a perfect match at IKEA.

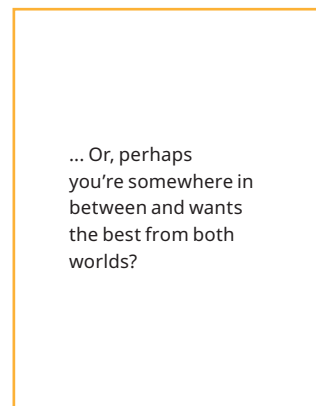
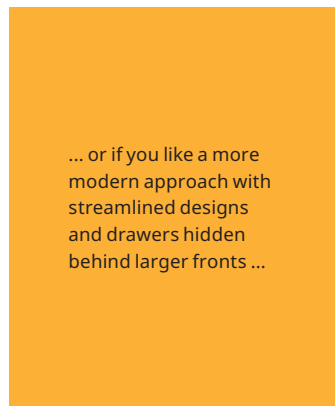
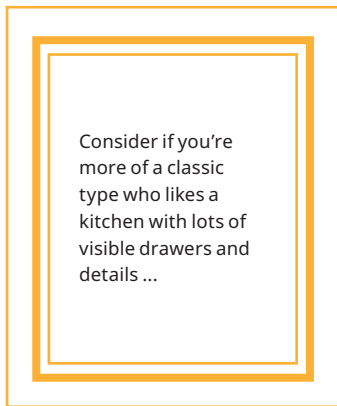

Discover all the styles, functions and ideas that we can provide you with.



The IKEA store

At your local IKEA store, you can stroll around in several built-up kitchens in different sizes and styles. Open up doors and drawers to reveal what's inside, check out the functions in our appliances and have a chat with our kitchen experts to get even more ideas.



The IKEA website

On our website, you'll find an abundance of stylish and functional ideas. In the kitchen gallery, we've prepared with kitchens in different styles and sizes. Plus, we've broken down each kitchen into its components to make it easier for you to mix, match and create the kitchen of your dreams. See more at [IKEA.co.uk/Kitchens](https://www.ikea.co.uk/Kitchens)

C: My Kitchen measurements

Be sure to make your measurements in millimeters, so your new kitchen fits your space right. **Squared Paper:** 1 square = 30cm

Ceiling Height _____
Distance between walls A _____ B _____ C _____

Don't forget:

- Mark the location of vents, air ducts and pipes
- Mark the location of electrical sockets, switches, water and gas connections (see pg. 7)

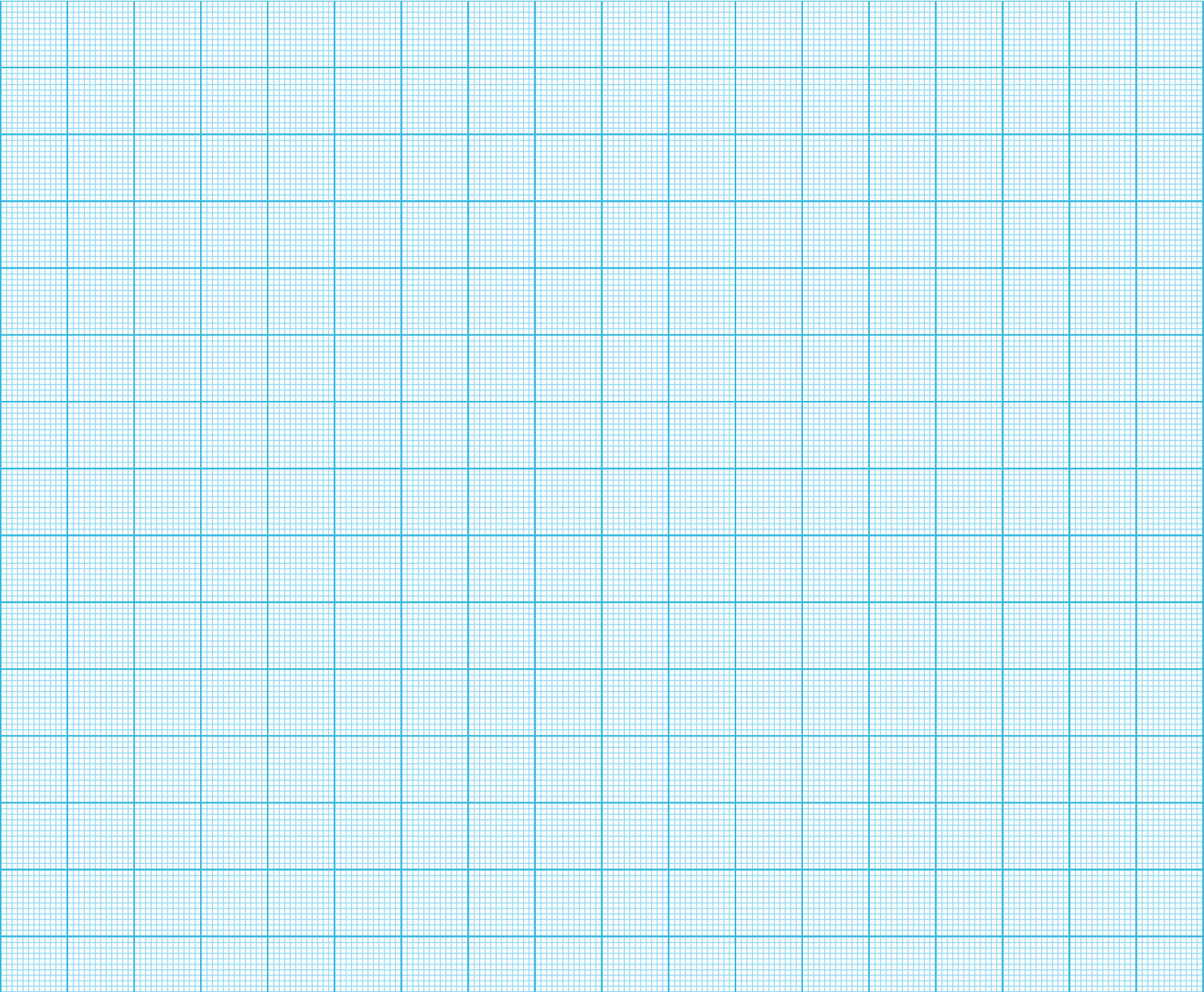

B: Planning

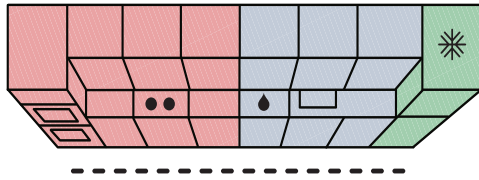

02 Single-line kitchens are perfect when space is limited. It's not strictly speaking a triangle, but the three points are still connected.

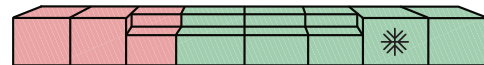
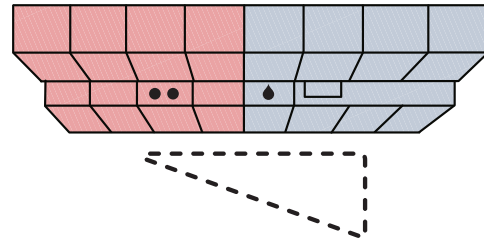

03 Galley kitchens are great if you have many people cooking at the same time. There's lots of room for food preparations and storage, too.

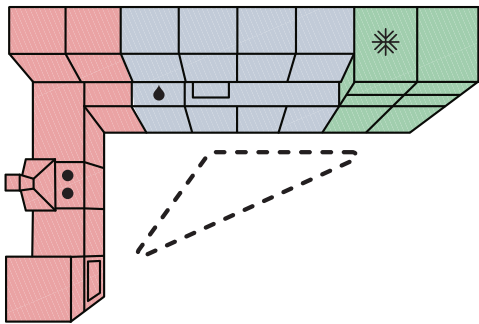

04 L-shaped kitchens make the most of a corner. They're ideal if you want to add a small dining table or kitchen island as well.

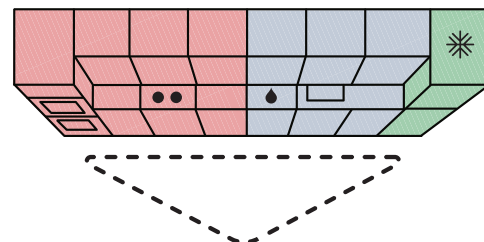

05 If you have space, adding an island to your kitchen gives you extra storage, lots of work space — plus, it's a great social hub. Give yourself 1200mm between the island and other cabinets to move around freely.

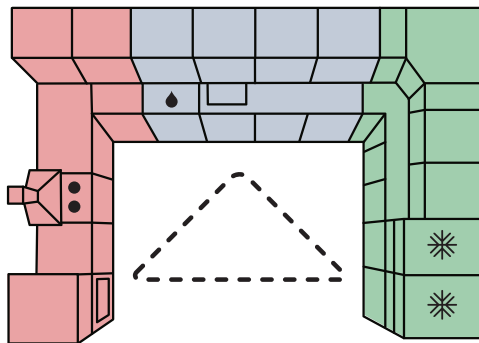

06 If you have a large room, the U-shaped layout is great. It gives you maximum space and plenty of storage options.

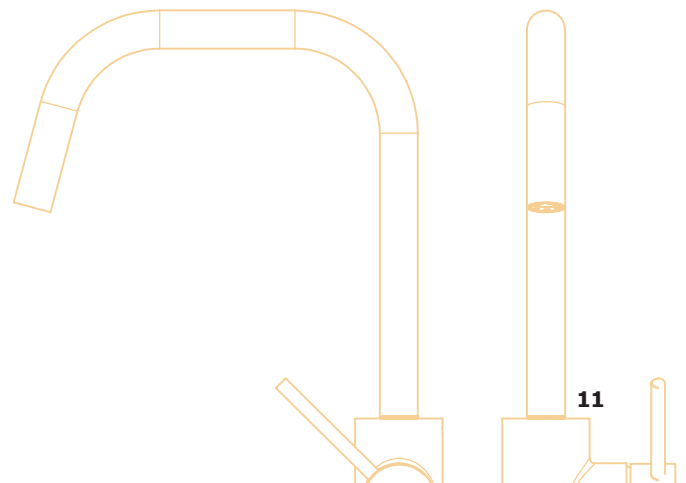

Dos and don'ts

Here are some recommendations, tips and what to avoid in order to get the most of your kitchen.

C: Recommendations

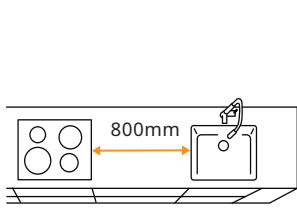

01 The best place for preparing food is the work surface between the cooktop and the sink.

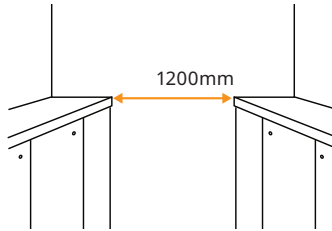

02 Make sure that the distance between opposite rows of cabinets is wide enough for doors on both sides to be opened at the same time.

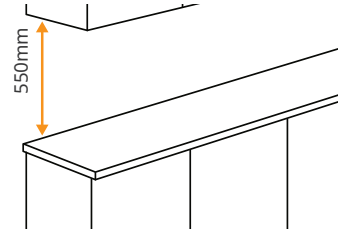

03 Place the wall cabinets high enough not to block the view over the worktop.

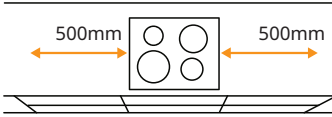

04 Make space next to the cooktop for pot stands to put hot pans on.

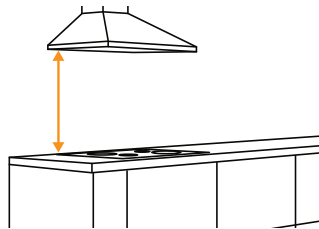

05 For safety and functionality, mount the extractor hood/fan at the recommended height above the cooktop as shown in the assembly instructions.

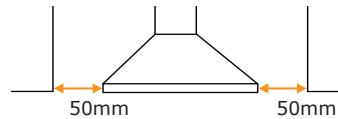

06 Leave space for cover panels if you'll have wall cabinets next to the extractor hood/fan.

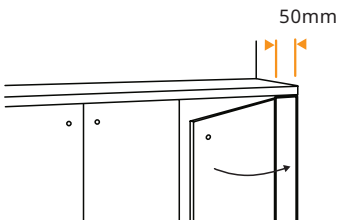

07 Place a 50mm filler piece between base as well as wall cabinets and the wall to ensure space enough to open doors and drawers fully.

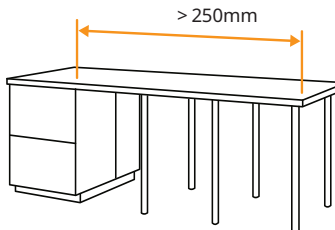

08 If the worktop protrudes over the cabinet more than 250mm add an extra support.

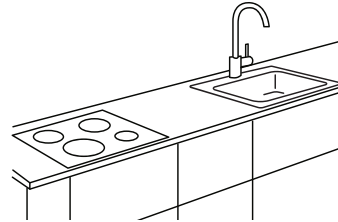

09 Place the sink and cooktop in the same line to avoid having to move hot objects over the floor.



D: Tips

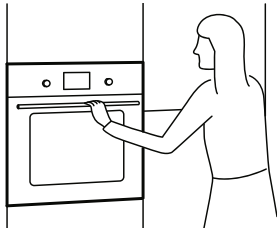

01 An elevated oven means you won't have to bend down to reach it.

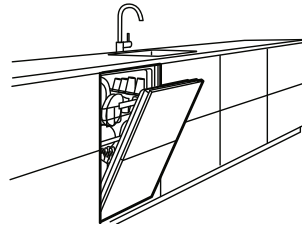

02 Locate the dishwasher close to the sink and draining board to make loading and unloading easier and to avoid spills on the floor.

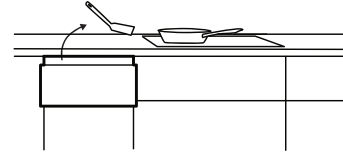

03 Keep utensils, pots and pans close to the cooktop and sink for easy access when preparing and cooking. Keep cutlery in a drawer close to the dinner table.

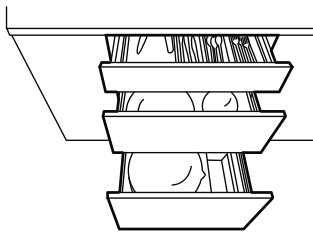

04 Drawers offer great overview and easy access to the things you need. Add drawer mats to keep things from moving around in the drawers and to reduce noise when putting things in drawers.

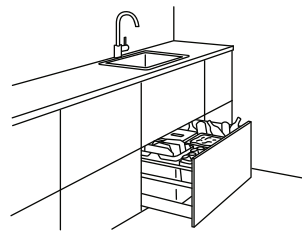

05 Place your waste sorting bins in a drawer under, or close to, the sink for easy access.



06 Electrical push openers are great if you have your hands full and need to open a drawer with your knee or elbow — and to avoid leaving stains on the fronts and handles with sticky fingers.



07 Optimize the space behind your fronts with inner drawers. The outside can stay sleek while the inside is filled to the brim with drawers.

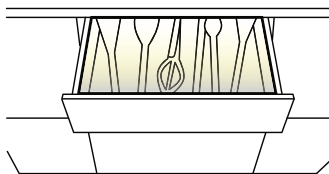

08 Use drawer lighting to find what you're looking for also when the kitchen isn't fully lit.

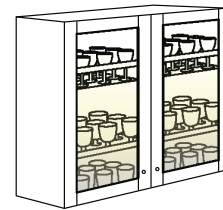

09 Display your finest glasses on tempered glass shelves behind glass doors. Add cabinet lighting to enhance a cozy atmosphere as well as to make the room look bigger.

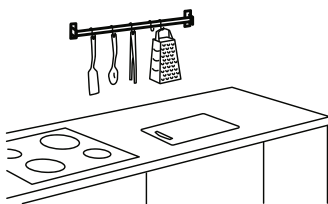

10 Use wall rails and accessories to make best use of wall space as well as to minimize clutter on the worktop. In addition, you'll get the things you use often close at hand for efficient cooking.



11 If you have the space, add a cart or a workbench for more storage possibilities and workspace.

E: Keep in mind

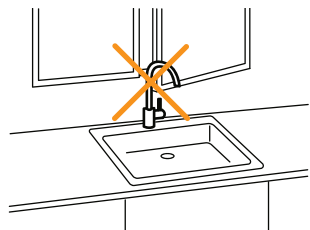

01 A sink by the window is nice when washing up. If your windows open inwards however, make sure they won't be blocked by the tap.

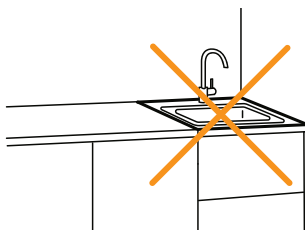

02 Placing a sink next to a wall or at the end of a row of cabinets disrupts work flow by limiting available workspace.

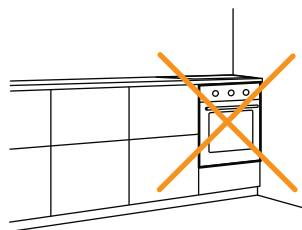

03 An oven next to a wall disrupts work flow by limiting available workspace, and it'll put the wall at risk from heat and cooking stains.

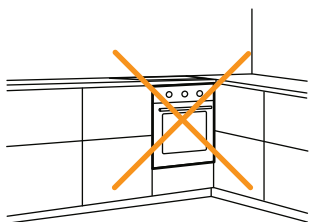

04 Positioning appliances like ovens, dishwasher or extractor hoods in corners might block cabinets and drawers from opening fully.

F: Small space solutions

When space is limited, you sometimes have to compromise to make it work.

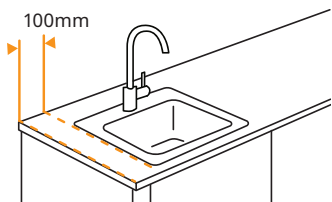

01 Use a small sink that fits into a 600mm cabinet. Make sure to have at least 4" between the sink and the edges of the worktop to make the construction sturdy.

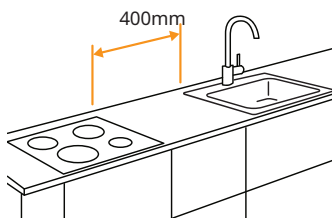

02 To have a good preparation area try to squeeze in at least 400mm worktop between the cooktop and the sink.

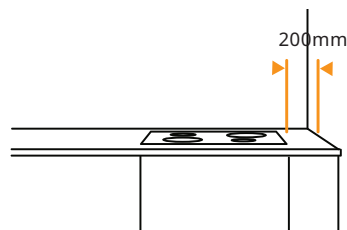

03 Have at least 200mm space between the cooktop and the wall for safe cooking.

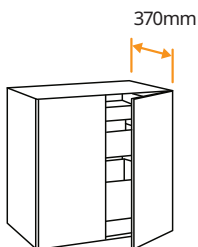

04 If your space is too narrow for 600mm deep cabinets, you can use 360mm deep cabinets instead.

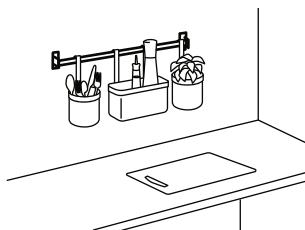

05 Make use of the wall to maximize storage opportunities and free up space on the worktop.



Order, get it home and install

When you're satisfied with your kitchen plan, it's time to order it

However, we recommend that you drop by your local IKEA store to visit our kitchen experts before you do. They'll help you with anything you feel uncertain about, and they'll go through your plan to make sure everything fits. Afterwards you can make your order right there and then if you like.

You have two options for how to place an order for your kitchen:

01

In the kitchen department at your local IKEA store

02

On our website:
www.IKEA.co.uk

IKEA Kitchens are designed to be installed by you

Start by picking up the kitchen installation guide at your local IKEA store (or use the digital version on the IKEA website). It shows you how to do it yourself, step-by-step. In addition it's important that you follow the assembly instructions that are included in all product packaging.

If you want help with complete installation you can take advantage of our Kitchen installation services. **page 19.**

Planning your kitchen project

Here are some helpful tips to think about when coordinating delivery, installation and worktops. It is good to start by setting an installation date to coordinate the following steps below.



Delivery

Arrange the delivery 5-7 days prior to your installation start date. Clear a space in a room adjacent to the kitchen. You will want to have space to assemble and arrange the boxes in sequence of installation. Upon delivery of your kitchen check your delivered products to make sure it matches your order. If you discovered missing and/or damaged products call 0203 645 0000 or visit your nearest IKEA for assistance.



Preparing

It's now time to get started! You should be preparing your space a minimum of 1 week prior to your installation. During this time you will be cleaning out all your cabinets, creating a temporary kitchen space in your home, removing your kitchen, patch, paint walls, flooring and electrical/plumbing preparations.



Installation

Our Installation Guide will show you step-by-step how to easily assemble and install your kitchen. Don't worry, if installation is not for you we have a team of installers who are able to complete the installation for you. Visit in store or at [IKEA.co.uk](https://www.ikea.co.uk) for further details on our installation services.

Finishing Touches

You are almost done! Once your worktop is in, this is the time to complete backsplash, touch up any painting, final plumbing and/or electrical. Finish off with a deep clean of your kitchen and you are ready to enjoy your brand new kitchen!

Services

You can do it yourself, but you don't have to

Our broad service offer gives you the freedom to design your own price tag by choosing not only the products that suits your budget but also deciding how much you want to do yourself and how much you want us to do for you.

Below you'll find all the services that we can offer.



Measuring

IKEA kitchen measurement service gives you a reliable foundation to plan your new kitchen – and peace of mind that all your planning will lead to perfection. Let our technicians provide correct measurements and document the necessary details.

Visit www.IKEA.co.uk/services for more information.



Kitchen planning

Get help with the planning of your new kitchen, by choosing one of our planning services. Our planners will help you with functional solutions for everything from the placement of cabinets to appliances, and storage to lighting and sinks.

In-store assisted self planning

Drop-in to an IKEA store and we can assist you with your kitchen plans.

In-store one-on-one planning, up to 2 hours

If you prefer, you can schedule one-on-one in-store planning appointment with one of our kitchen experts.

Online kitchen planning, up to 2 hours

Don't live near an IKEA? Our online planning service is perfect for you and you don't even need to leave your home. We will plan over the internet.

Visit IKEA.co.uk for pricing and to book your appointment today!

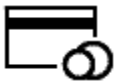

Payment options

We accept many payment methods, including cards and cash. And if you need a little longer to settle your bill, we can help you spread the cost

Visit www.ikea.co.uk/kitchens for more information.

YOU CAN DO IT YOURSELF BUT YOU DON'T HAVE TO



Delivery

Whether you're shopping in store or online, no matter how big the purchase, we'll do the heavy lifting and bring it all to your home or business.



Buy it Online

Shopping on [IKEA.co.uk](https://www.ikea.co.uk) couldn't be easier. You'll find an incredible variety of products, not to mention some of the best home furnishing tips and inspiration around. Shop on the go or without ever having to leave your sofa. The choice is yours. Either way, we'll have your order delivered to your home within just a few days.



Click and collect

Save some time by placing your order online. We'll round up everything on your shopping list and have it ready for you to collect at the time and location of your choice.



Buy it in the store

Have a seat, talk to our kitchen specialists, open and close doors and drawers. Get to know our products and home furnishing solutions in the best way we know how: up close and personal, with knowledgeable staff to help answer all of your questions. And since most of our items are flat-packed, you'll be able to have them delivered or take them home with you the same day.



YOURSELF, SAVE TO



IKEA Kitchen installation

IKEA kitchen installation service gets your dream kitchen up and running as fast as possible – so you can start making your favorite recipes and new memories. Save yourself valuable time while trusted professionals finish your kitchen for you.

Our installation service can save you valuable time, especially when it comes to the trickier jobs like fitting sinks, worktops and appliances. Thanks to the 5-year workmanship guarantee included, you can feel confident that your kitchen will be installed to the highest industry standards.

How IKEA kitchen installation service works

Our Kitchen Specialists will discuss, and provide, an installation quotation during your planning appointment. Installation of a new kitchen is an exciting and comprehensive project and we want to help you stay on track! Below is a summary of your kitchen installation journey, highlighting the key points.

Kitchen installation service includes:

- Assemble, fit and secure IKEA cabinets.
- Fit and secure all filler pieces, cove panels, deco strips and cornices plinths.
- Cut and mitre IKEA laminate and custom-made worktops (stone worktops not included).
- Mount IKEA cabinet lighting with cord management (plug in only).
- Install IKEA supplied appliances (electrical/gas connection not included).
- Install IKEA supplied sinks and taps and connect waste pipes to sink (plumbing connection not included).
- Clean up and dispose of waste (if you have opted for the waste disposal service).

For more information visit www.IKEA.co.uk/services



IKEA Kitchen Planner

Design the METOD kitchen of your dreams in a 3D environment and get a price on every detail as well as the total kitchen. Print out your drawings and product list at home, or save to the IKEA website. At the IKEA store you can discuss your design and get lots of advice and guidance from our kitchen experts. Learn more at [IKEA.co.uk/kitchens](https://www.ikea.co.uk/kitchens)



[IKEA.co.uk/ Kitchens](https://www.ikea.co.uk/kitchens)

On our webpage you'll find lots of inspiration and ideas to get the most out of your kitchen, whether it's a new one or an old that you want to freshen up. Plus, here you'll find all products that you can imagine to personalise and create the kitchen of your dreams.



ENHET Kitchen configurator

You can rely on the ENHET kitchen configurator to make your purchase as fast and smooth as possible. Online you will find a display of the ready made complete kitchen solutions that our design experts have put together. After having selected your favourite solution with just one-click, you can customize features, such as fronts, worktop, sink, faucet, knobs/handles and appliances.

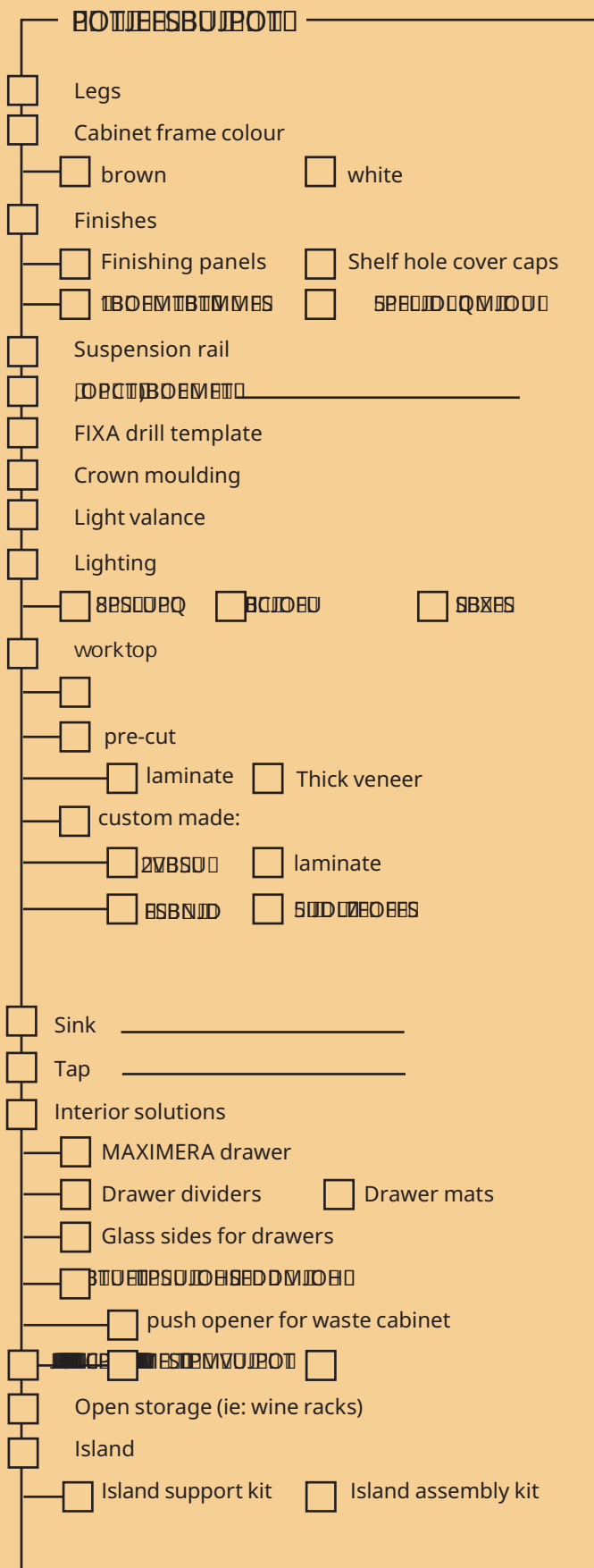

MEASUREMENTS

HEIGHT

Measure the height of the cabinets, including the base and high cabinets, and divide by the length of your suspension rail to get the number of rails needed.

WIDTH

Finishing panels: To cover any exposed side of your cabinet(s). You can also use cover panels to create a gable for your fridge or dishwasher.

Measure the widths of all cabinets, including base and high cabinets and divide by the length of your valance or crown moulding strips to get the number of strips needed.

VALANCE OR CROWN MOULDING

Measure the widths of all cabinets, including base and high cabinets and divide by the length of your valance or crown moulding strips to get the number of strips needed.

TOOL MARKING

This simple tool helps you easily and accurately mark where you want to place your knobs and handles.

STRIPS

Measure the widths of your wall cabinets and any exposed sides, then divide by the length of your valance or crown moulding strips to get the number of strips needed.

ISLAND

Island support kit: to attach cover panels to back of cabinets.
Island assembly kit: to secure cabinets.

ISLAND

Island support kit: to attach cover panels to back of cabinets.
Island assembly kit: to secure cabinets.

NEED HELP?

You can contact us in different ways:

Online

Read the FAQs —they might answer your question: [IKEA.co.uk/FAQ](https://www.ikea.co.uk/FAQ)

In Person

Speak to us in store —those friendly people in the yellow shirts are ready to help you through your buying process.

By phone

If you ever need to talk to us in person, we're happy to answer your call. You can reach us over the phone at: 0203 645 0000

Installation Services

Save time and effort with installation
For full details visit [IKEA.co.uk/kitchens](https://www.ikea.co.uk/kitchens)

**Remember,
it's okay to change
your mind.**

For more information, please see our Return policy on [IKEA.co.uk/returnpolicy](https://www.ikea.co.uk/returnpolicy)

